

INFRALAN® OC45 Keystone Class E_A

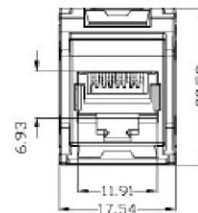
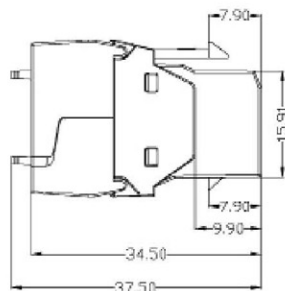
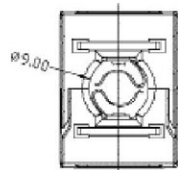
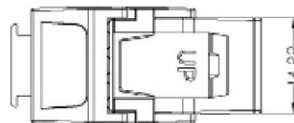
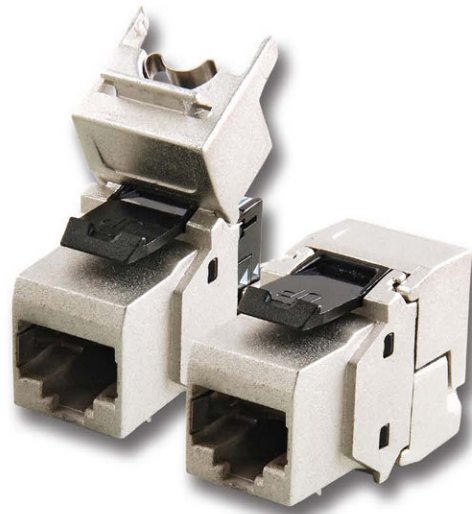

Product Details:

- Screened Class E_A Keystone Jack

Approvals:

- Screened Permanent Link Class E_A by GHMT
- Screened Channel Link Class E_A by GHMT
- Applicable Specifications:

TIA/EIA-568-C.2 (2009-08)
ISO/IEC 11801 AMD2 (2010-04)
IEC 60603-7-51
PoE+ IEEE802.3at

Electrical Specifications:

- Insulation Resistance: > 500 M Ω
- Dielectric Withstand Volt: 100 V AC RMS 60 Hz
- Contact Resistance: < 20 m Ω
- Current Rating: 1.5A @ 68°F
- EMV-EN 50082-1; EN 55022

Mechanical Specifications:

- Plug Insertion Life: > 750 times plug in
- Temperature Range: -40°C ~ +66°C
- Contact Plating: 50 μ “ gold plated over contact area

Packaging:

- Each in poly bag, including instruction manual
- Included accessories: dust cover, copper foil, cable tie

RoHS
compliant

| | |
|-----------------|------------------|
| Created MN | Date 29.10.09 |
| Last rev. EP | Date 17.04.12 |

INFRALAN® OC45
Keystone Class E_A
E-20070



Front

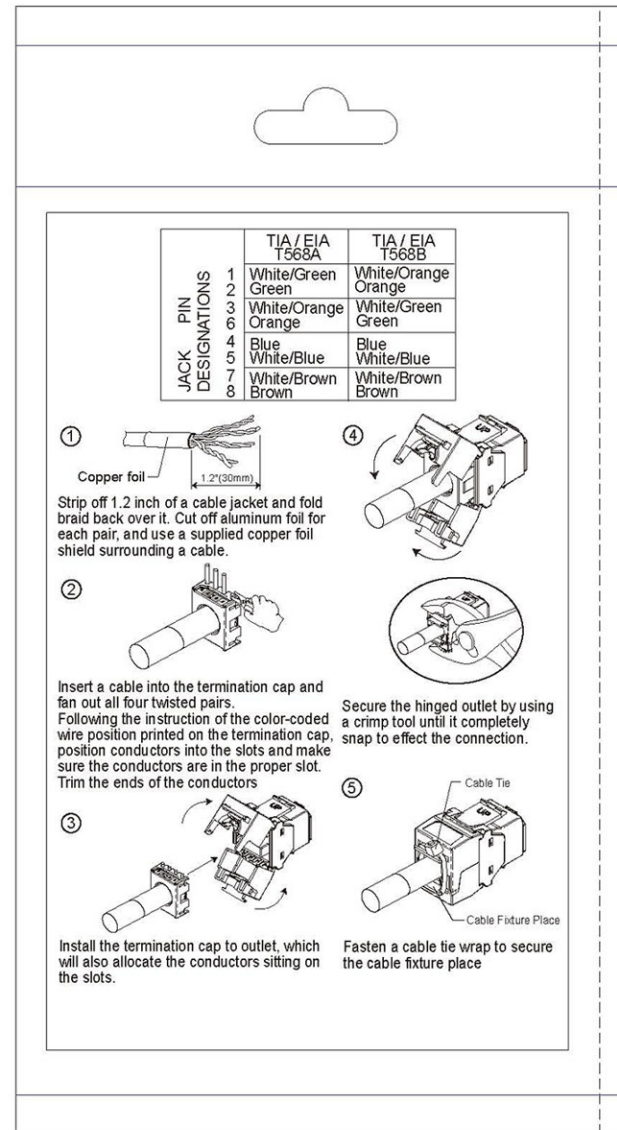
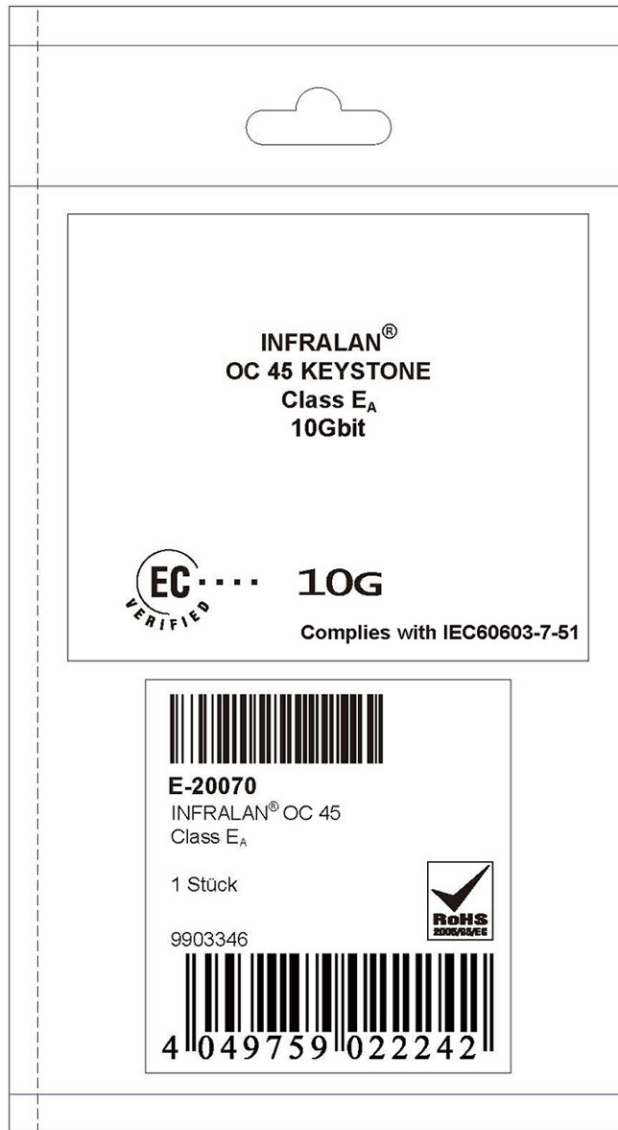

Back

| | |
|-----------------|------------------|
| Created MN | Date 29.10.09 |
| Last rev. EP | Date 17.04.12 |

**INFRALAN® OC45
Keystone Class E_A
E-20070**

File: E-20070_ENG

